



Slot Diffusers

LDK

LDK | Slot Diffusers

Description

LDK linear slot diffusers are designed to meet high comfort requirements and modern slot diffuser application standards.

LDK slot diffusers, providing a modern architectural appearance and excellent air distribution characteristics; ideal for fan coils, VAV boxes and traditional linear slot applications. Available up to 8 slots as standard, for wall or ceiling mounting. The diffuser profile is made of aluminium and the air guide wings are made of plastic material. Slot diffusers can be manufactured as a single piece up to 2 meters as standard. With effective alignment strips, the separate diffusers can be combined with the desired length of slot diffusers to create longer slot diffusers. As the points of assembly are almost invisible, they do not cause any visual discomfort.

The plastic wings can be easily removed and installed from the diffusers profile, thus ensuring easy access and mounting for the rear of the diffuser. Alternatively, the plastic wings may be provided in small cross-sections of 100 mm (Type LDKP). This allows multi directional air distribution.

The standard border profile detail includes a 30mm side flange and an optional edge closure.

In addition, PLDK plenum boxes manufactured in accordance with LDK slot diffusers and they are made of galvanized steel. They can be produced in any size. The connection of the diffusers to the plenum boxes is carried out by means of the mounting brackets which appear after removing the plastic air guide blades on the diffuser.

LDK Slot Diffusers are standard white powder coated and air distribution blades are matte black. Colors can be changed according to customer request.

Depending on the architectural requirements, slot diffusers can be produced as curved.

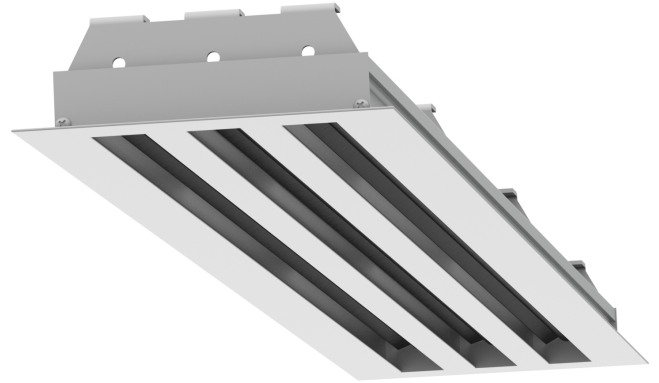

3 slot linear slot diffuser

Throw directions

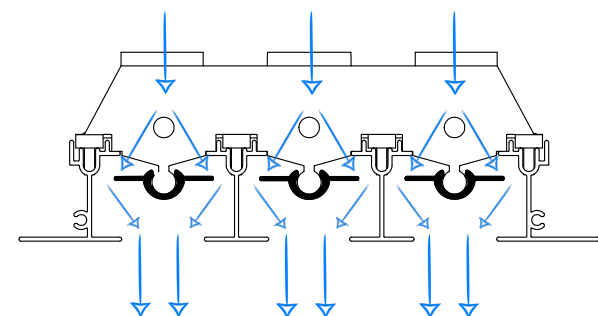
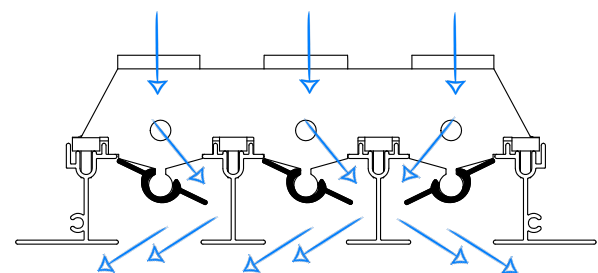
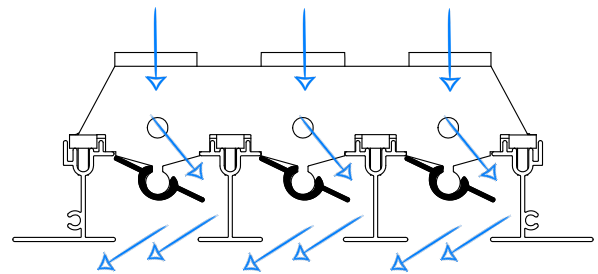

Selection Procedure

1. In order to provide the best air distribution in the air conditioned zone, decide the distribution position of the diffusers.
2. Determine the maximum advised noise level of the room from table 1.
3. Devide the total air volume (m³/h) by the active diffuser length and determine the unit air volume amount per meter.
4. Determine the throw distance from the performance specifications.
5. Determine the number of slot rows by using the scale table.

Selection Example

A 5 m slot diffuser is existing in an office area and the total air volume is asked to be 1440 m³/h.

0,25 m/s air velocity is required at 8,5 m throw distance.

From the table above, we read the maximum NC level as 30-40 for office areas.

Our air volume per meter is $1440/5 = 288 \text{ m}^3/\text{h}$

If we check the scale table with these values we read that, at 6 m throw distances a 2 slotted diffuser is suitable.*

As the slot diffuser is designed to be 5 m, it should be multiplied by throw distance correction factor 1,4. And this gives us 8,4 m throw distance. Noise level is read to be >NC25 . When noise level correction factor +4 is added, we reach >NC30. 29 Pa pressure loss can be considered for this selection.

*Please contact Step Mekanik office for detailed throw distance selection print outs.

Area to be served	Recommended Maximum NC Levels
Sound Broadcasting Recording Studios, TV (Audience Studios)	15 - 20 20 - 25
Lecture Theatres, Cinemas, Concert Halls, Boardroom/ExOffices Lounge, Conference Room, Court Room, Churches, Private Bedrooms	25 - 30
Operating Theatres, Hospital Wards, Staff Room, Class Rooms, Ballroom, Banquet Room, Library, Bank, Museum, Offices	30 - 40
Restaurants, Department Stores, Computer Suite, Washroom Toilet	35 - 40
Laundries, Kitchens, Swimming Pools, Sports Arena	40 - 45
Garage, Light Engineering Workshop	45 - 50
Heavy Engineering Workshop	50 - 65

LDK | Slot Diffusers

Diffuser Dimensions

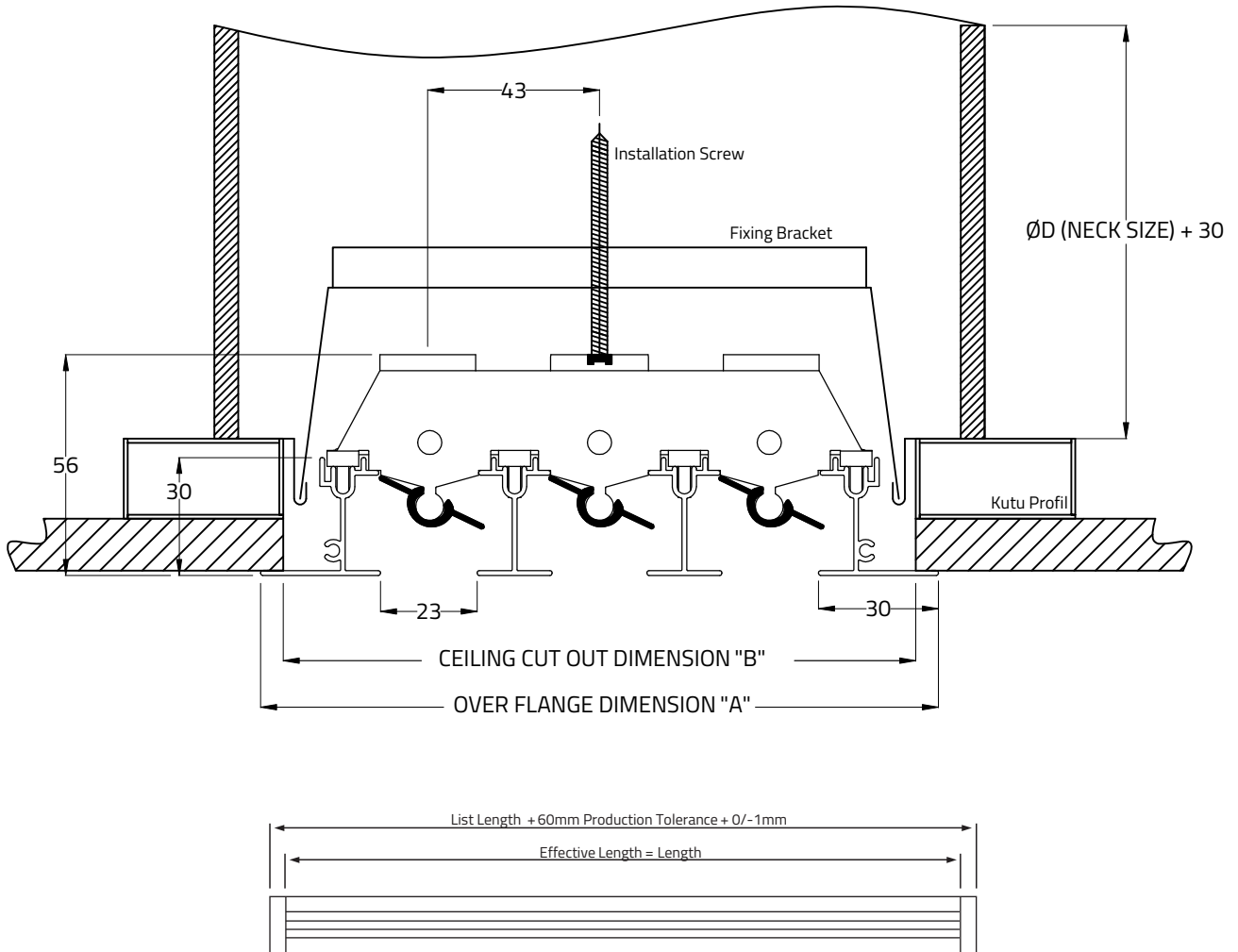

Model	Slot Numb.	"A"	"B"
LDK	1	83 mm	67 mm
LDK	2	125 mm	109 mm
LDK	3	167 mm	151 mm
LDK	4	209 mm	193 mm
LDK	5	251 mm	235 mm
LDK	6	293 mm	277 mm
LDK	7	335 mm	319 mm
LDK	8	377 mm	361 mm

Concealed Type Of Ceiling Profile

LDK/G slot diffuser is designed for applications in which the border profiles of slot diffusers are asked to be invisible.

They are suitable for single or multi part installations and can be produced as 1,2,3 or 4 slot rows.

After the installation, the frame lays in the space left in the suspended ceiling and only a black narrow line can be seen from the bottom.

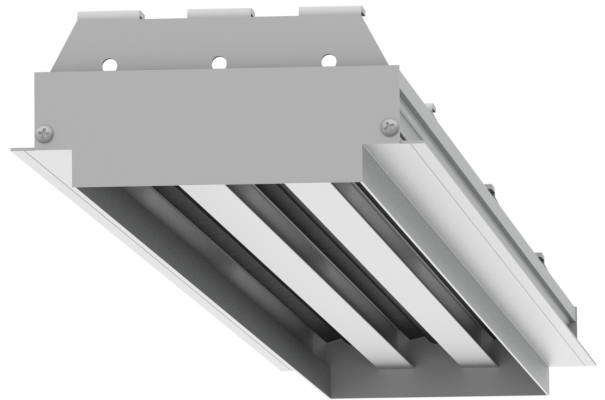

Size and Installation Methods

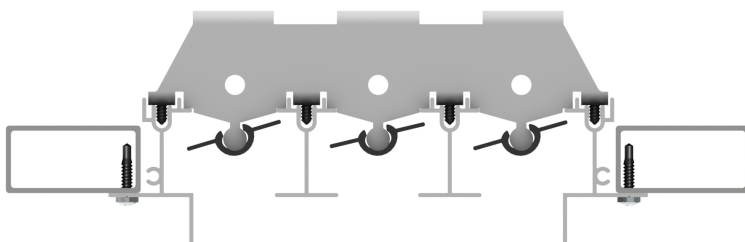
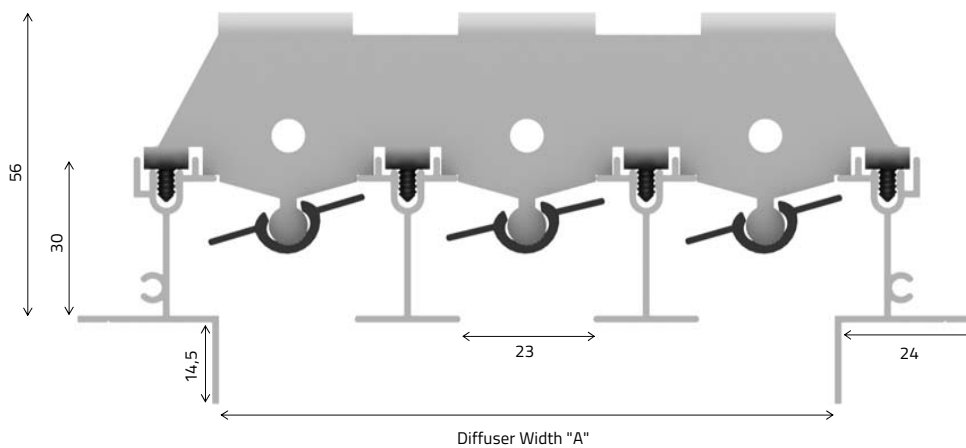

Slot Numb.	A [mm]
1	23
2	65
3	107
4	149

LDK | Slot Diffusers

Appearance After Installation

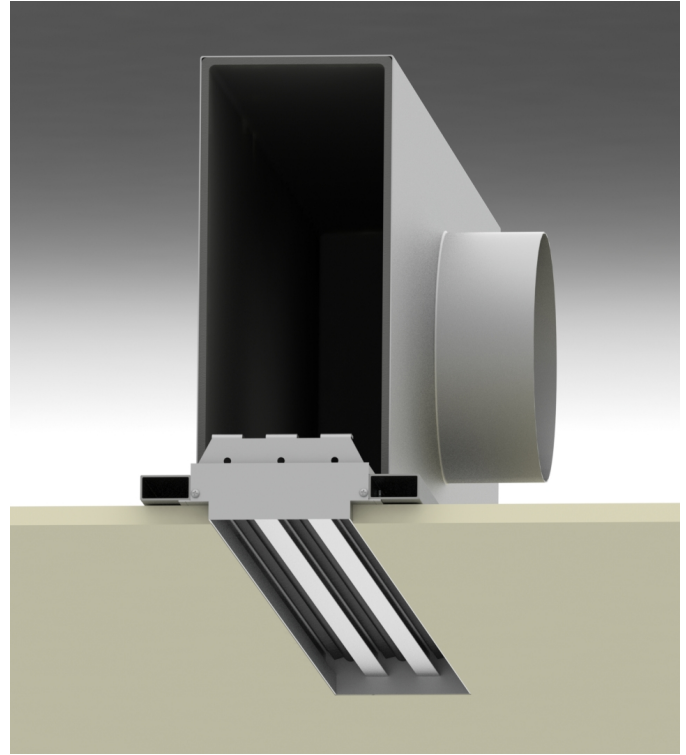
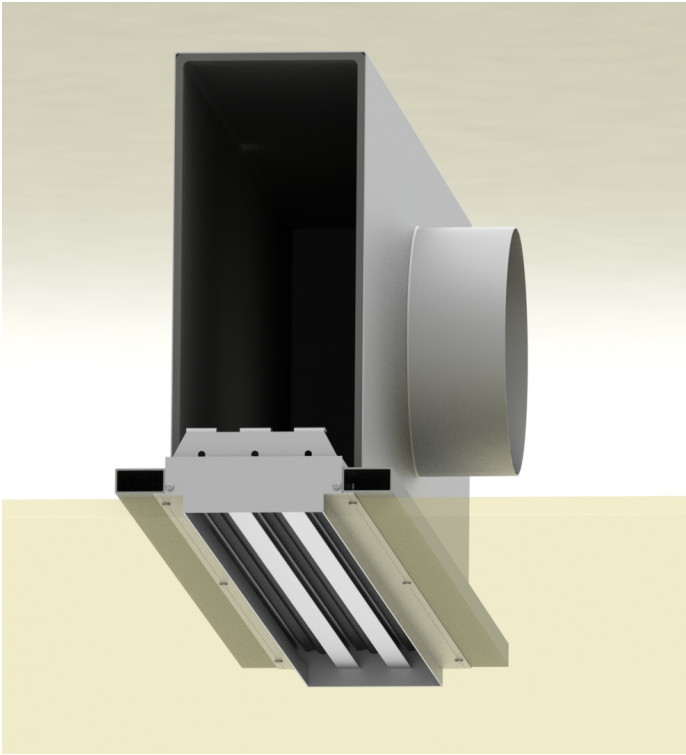

End Flange Details

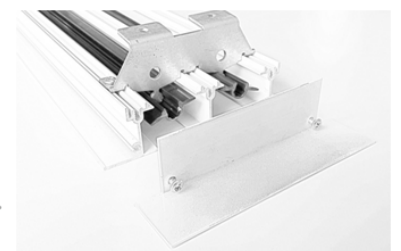
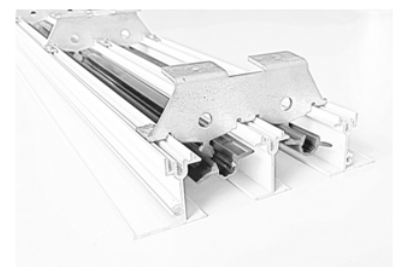
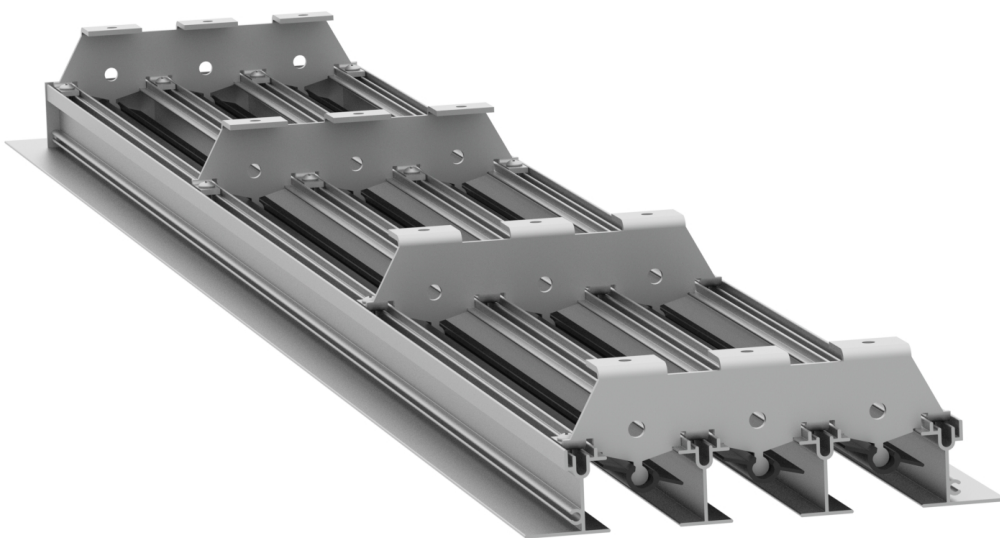

Air Volume – Noise Level – Pressure Loss Graphics

1 Slot

Horizontal Throw

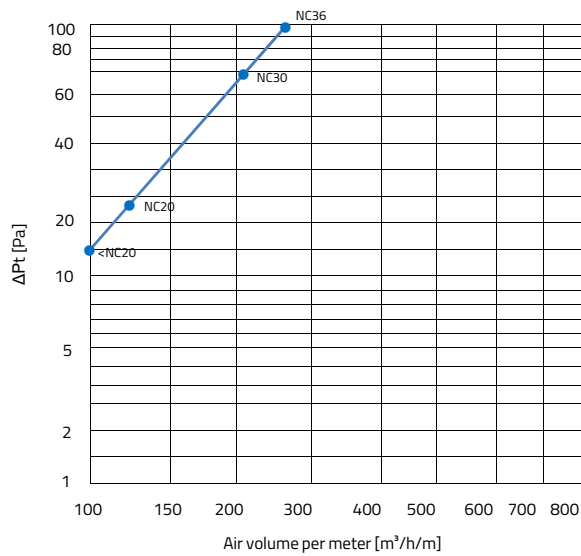

Vertical Throw

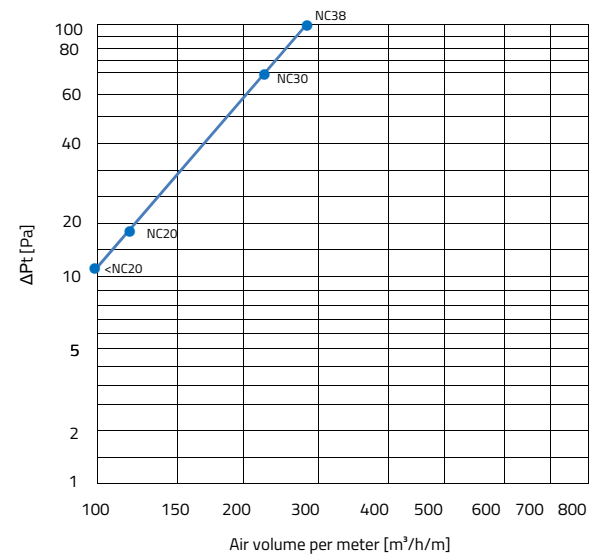

2 Slot

Horizontal Throw

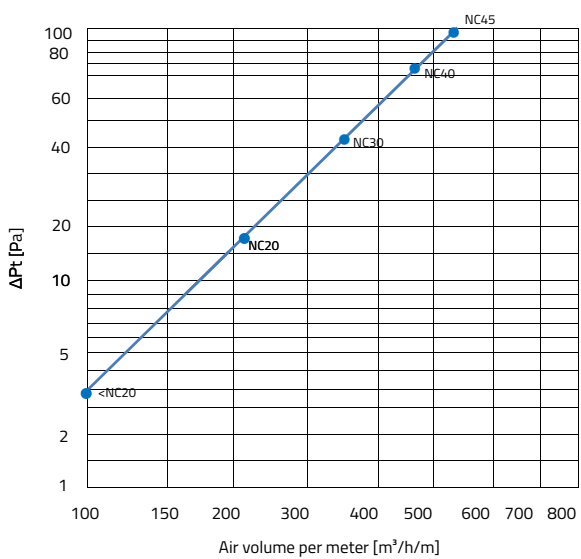

Vertical Throw

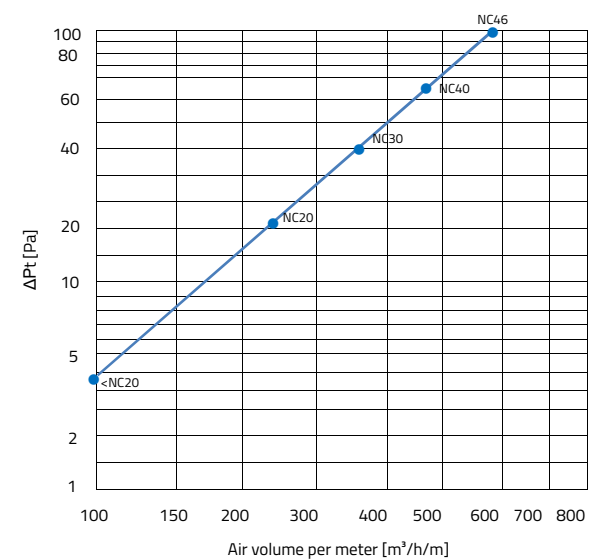

Length	0,9	1,0	1,2	1,5	2,0	3+
NC Value Addition	-1	0	+1	+2	+3	+4

LDK | Slot Diffusers

Air Volume – Noise Level – Pressure Loss Graphics

3 Slot

Horizontal Throw

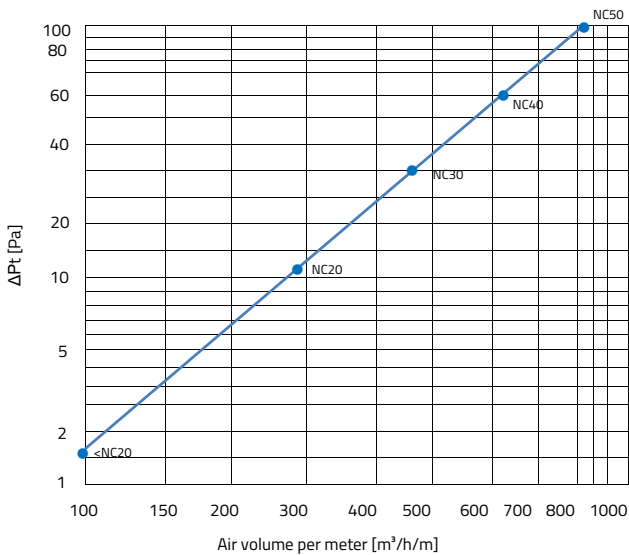

Vertical Throw

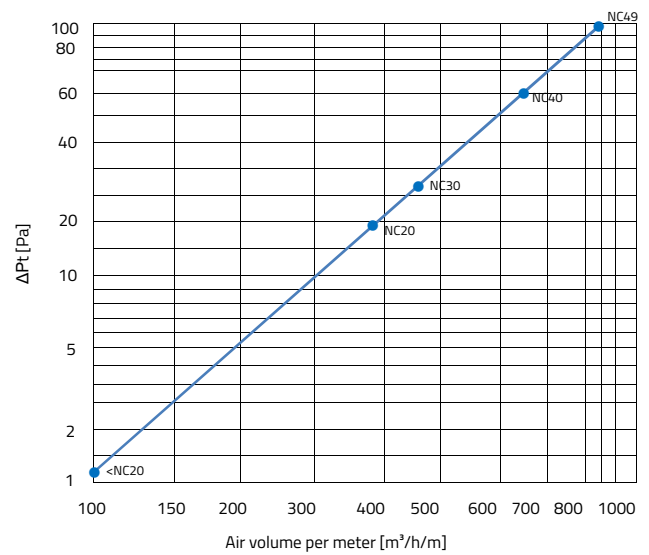

4 Slot

Horizontal Throw

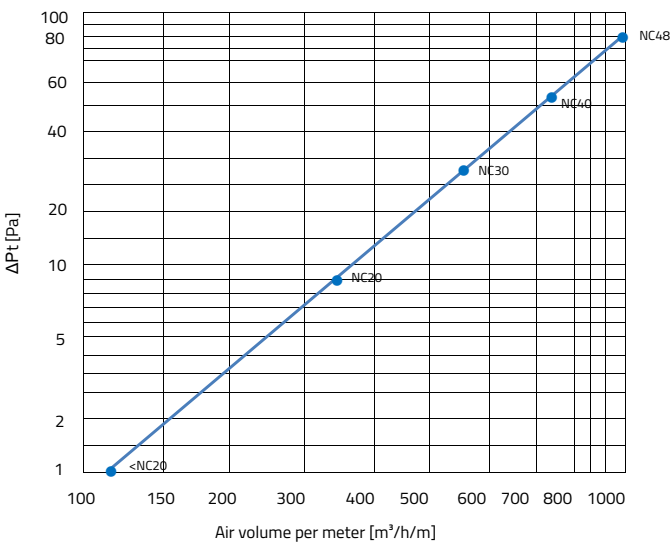

Vertical Throw

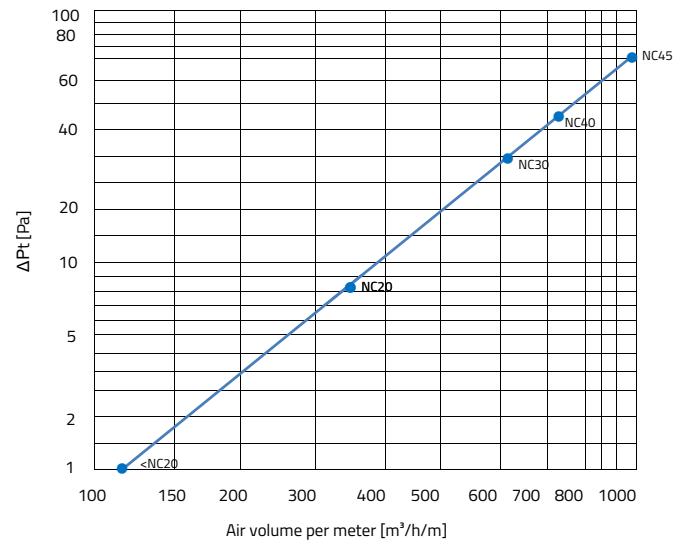

Length	0,9	1,0	1,2	1,5	2,0	3+
NC Value Addition	-1	0	+1	+2	+3	+4

Ordering Code

LDK 1 / P / D / RAL..

(1) (2) (3) (4) (5)

- | | | |
|-----|------------|--|
| (1) | Model | LDK = Slot Diffuser
LDK/G = Hidden Flange Slot Diffuser |
| (2) | Slot Numb. | 1 = 1 Slot
2 = 2 Slot
3 = 3 Slot
4 = 4 Slot
up to 8 slot |
| (3) | Plenum | P = With Plenum
- = Without Plenum |
| (4) | Version | D = Supply
T = Return |
| (5) | RAL Code | RAL = Color Code |

